

Livox Mid Series

User Manual v1.2

2019.08

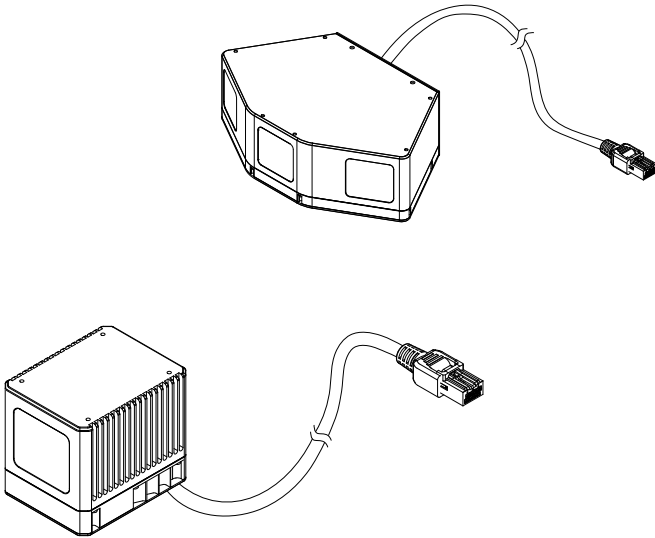

Searching for Keywords

Search for keywords such as “FOV” and “mount” to find a topic. If you are using Adobe Acrobat Reader to read this document, press Ctrl+F on Windows or Command+F on Mac to begin a search.

Navigating to a Topic

View a complete list of topics in the table of contents. Click on a topic to navigate to that section.

Printing this Document

This document supports high resolution printing.

Using this Manual

Legend

 Warning

 Important

 Hints and Tips

 Explanation

Downloading Documents

Visit the link below to download the latest Livox Mid Series User Manual and other documents related to the Livox Mid series.

www.livoxtech.com/mid-40-and-mid-100

Downloading Livox Viewer

Visit the link below to download Livox Viewer.

www.livoxtech.com/mid-40-and-mid-100

Downloading Livox SDK

Visit the link below to download Livox SDK:

<https://github.com/Livox-SDK>

Contents

Using this Manual	2
Legend	2
Downloading Documents	2
Downloading Livox Viewer	2
Product Profile	4
Introduction	4
Product Characteristics	4
Overview	6
Connectors	8
LiDAR Connector	8
Power Cable and Sync Cable	9
Ethernet Port	9
Mounting the Livox Mid Series	10
Effective Field of View (FOV) Range	10
Dimensions	10
Getting Started	12
External Power Supply	12
Connection	13
Usage	15
Coordinates	15
Output Data	15
Working States & Working Modes	17
Rain/Fog Suppression	18
Livox Viewer	18
Software Development Kit (SDK)	23
Storage, Transportation, and Maintenance	23
Storage	23
Transportation	23
Maintenance	23
After-sales information	24
Troubleshooting	24
Appendix	25
Appendix 1	25
Appendix 2	26
Appendix 3	26
Appendix 4	27
Specifications	27

Product Profile

Introduction

The Livox Mid-40 and the Livox Mid-100 are high-performance LiDAR sensors that can be used for multiple applications including autonomous driving, robot navigation, dynamic path planning, and high-precision mapping.

Both the Livox Mid-40 and Livox Mid-100 have a detection range of up to 260 meters.

Non-repetitive Scanning Technology: The unique non-repetitive scanning technology owned by Livox ensures a high-density point cloud, and can precisely detect every detail inside the field of view (FOV).

High Reliability: The Livox Mid series has undergone high-temperature endurance tests, salt spray tests, and other rigorous reliability testing required by the automotive industry. In addition, the Livox Mid series has achieved an IP67 waterproof and dustproof rating under GB 4208-2008 and IEC 60529 standards.

Environmental Adaptation: The Livox Mid series maintains a consistent performance in a wide range of lighting conditions, from 100 kilolux to darker, low-visibility environments. Thanks to the innovative de-noising algorithms built-into the unit, the Livox Mid series is able to effectively reduce the noise caused by atmospheric particles such as rain, fog, and dust, as well as interference from other LiDAR sensors.

User-friendly Livox Viewer: Livox Viewer is a Windows software specially designed for Livox LiDAR sensors. It displays real-time point clouds, and the simple interface makes it easy to use.

Livox SDK: A software development kit (SDK) is provided to help develop customizable applications using the data acquired from point clouds.



- 260 m can be reached when the target object reflects 80% or more of light (e.g., grey concrete walls and roads have a reflectivity range from 15% to 30%, while white plaster walls have a reflectivity range from 90% to 99%) in an environment with a temperature of 77° F (25° C).
- The Livox Mid-40 and the Mid-100 have basically the same functionalities. The only difference between the Livox Mid-40 and Livox Mid-100 is that the Livox Mid-100 is a three-in-one version of the Livox Mid-40. The general descriptions in the user manual apply to both the Livox Mid-40 and Livox Mid-100.
- Remove the protective film on the optical window before first use.

Product Characteristics

The Livox Mid-40 and Livox Mid-100 have a high coverage ratio due to their unique non-repetitive scanning technology. Over time, the coverage inside the FOV increases significantly and reveals more detailed information of the surroundings.

Figures 1.2.1 and 1.2.2 display the typical point cloud patterns of the Livox Mid-40 and Livox-100 over an extended period. The point cloud pattern of the Livox Mid-100 is composed of the point cloud patterns of three Livox Mid-40 LiDAR sensors.

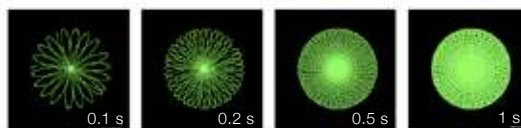

Figure 1.2.1 Point cloud patterns of the Livox Mid-40 accumulated over an extended period

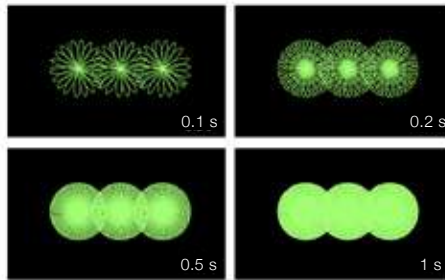

Figure 1.2.2 Point cloud patterns of Livox Mid-100 accumulated over an extended period

Figure 1.2.3 displays the FOV coverage of Livox LiDAR sensors compared with other non-Livox LiDAR sensors that use common mechanical scanning methods. The diagram shows that when the integration time is less than 0.1 seconds, the FOV coverage of the Livox Mid-40 is similar to the 32-line LiDAR sensor. As the integration time increases, however, the FOV coverage of the Livox Mid-40 increases significantly while the 32-line LiDAR sensor remains the same. After 0.5 seconds, the FOV coverage of the Livox Mid-40 is the same as the 64-line LiDAR sensor. After 1.4 seconds, the FOV coverage would approach 100%, so almost all areas would be illuminated by laser beams. In this way, more details in the FOV can be revealed.

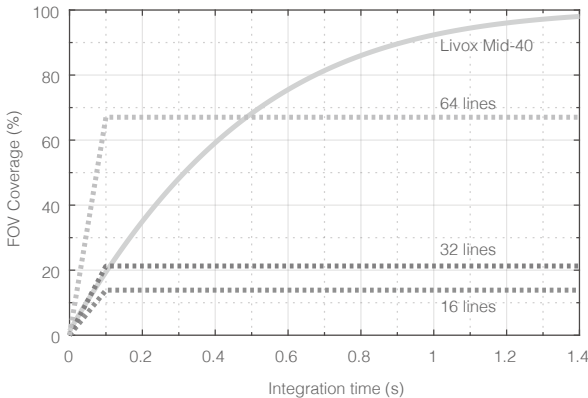



Figure 1.2.3 The FOV coverage of the Livox Mid-40 and non-Livox LiDAR sensors using common mechanical scanning methods. The 16-line non-Livox LiDAR sensor has a vertical FOV of 30°, the 32-line non-Livox LiDAR sensor is 41°, and the 64-line non-Livox LiDAR sensor is 27°.

 The performance of the scanning method is defined by the FOV coverage, which is calculated as the fraction of FOV illuminated by laser beams. The FOV coverage (C) can be calculated with the following formula:

$$C = \frac{\text{Total area illuminated by laser beams}}{\text{Total area in FOV}} \times 100\%$$

Refer to the official Livox website for more information about how the FOV coverage is calculated.

Laser Wavelength	905 nm
Laser Safety	Class 1 (IEC 60825-1:2014) eye safe
Detection Range (@100 klx)	90 m @ 10% reflectivity 130 m @ 20% reflectivity 260 m @ 80% reflectivity
FOV	Livox Mid-40: 38.4° (circular) Livox Mid-100: 98.4° (Horizontal) × 38.4° (Vertical)
Range Precision (1σ @ 20 m)	2 cm
Angular Accuracy	< 0.1°
Beam Divergence	0.28° (Vertical) × 0.03° (Horizontal)
Point Rate	Livox Mid-40: 100,000 points/s Livox Mid-100: 300,000 points/s
False Alarm Ratio (@100 klx)	< 0.01%

Table 1.2.1 Point cloud specifications



- The Livox Mid series cannot detect objects which are less than 1 m away. Contact Livox if you require LiDAR sensors that can detect objects within a range of 1 m.
- The range precision was tested in an environment at a temperature of 77° F (25° C) with a target object that had a reflectivity of 80% and was 20 m away from the Livox Mid series LiDAR sensors. The actual environment may differ from the testing environment. The figure listed is for reference only.

Overview

Livox Mid-40

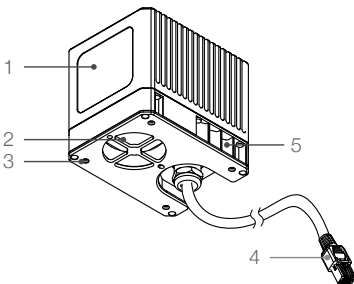

1. Optical Window

The laser passes through the optical window and scans objects in the FOV.

2. Fan (Air Inlet)

Only dissipates heat when the temperature of the LiDAR sensor is high. Make sure there are at least 10 millimeters between the fan (air inlet) and the nearest objects.

3. Mounting Holes

M3 mounting holes. Make sure to use the correct screws when mounting.

4. LiDAR Connector

Connects to the Livox Converter. The LiDAR Connector can be customized. Refer to the Cables section for more information.

5. Air Outlet

Dissipates heat. Make sure there are at least 10 millimeters between the air outlet and the nearest objects.

Livox Mid-100

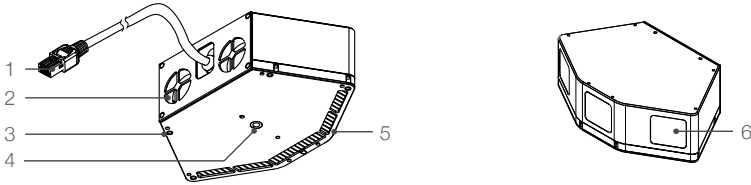

1. LiDAR Connector

Connects to the Livox Converter. The LiDAR Connector can be customized. Refer to the Cables section for more information.

2. Fan (Air Inlet)

Only dissipates heat when the temperature of the LiDAR sensor is high. Make sure there are at least 10 millimeters between the fan (air inlet) and the nearest objects.

3. M3 Mounting Holes

M3 mounting holes. Make sure to use the correct screws when mounting.

4. ¼ Inch Mounting Hole

Can be mounted on a tripod or other bases outfitted with a ¼ inch screw.

5. Air Outlet

Dissipates heat. Make sure there are at least 10 millimeters between the air outlet and the nearest objects.

6. Optical Window

The laser passes through the optical window and scans objects in the FOV.

Livox Converter

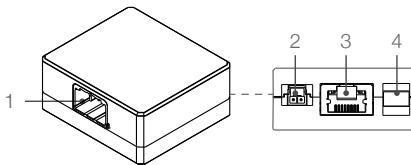

1. LiDAR Connector Port

A JAE MX34012NF1 type connector port used to connect to Livox Mid series LiDAR sensors. Only compatible with JAE MX34012SF1 type LiDAR connectors.

2. Power Port

A MOLEX 105313-1102 type power port used to connect to an external power supply. Only compatible with MOLEX 105307-1202 (LiDAR) connectors.

3. Ethernet Port

An RJ45 type Ethernet connector used to connect to Ethernet cables.

4. Sync Port

A JST SM03B-GHS-TB type sync port used to connect to sync cables. Only compatible with JST GHR-03V-S type connectors.

Connectors

LiDAR Connector

Below is more information on the LiDAR connector and extensible power cables connector. Users can customize the connectors based on their needs for power supply, data transmission, and data synchronization.

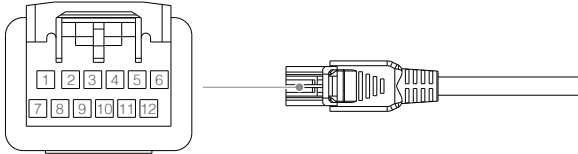

Figure 2.1.1 LiDAR and Extensible Cable Connector

Pin	Signal	Type	Description
1	Power+	Power	DC 10-16 V(max 16 V)
2	Ground	Power	Ground
3	Ethernet_TX+	Output	100BASE-TX, TX+
4	Ethernet_TX-	Output	100BASE-TX, TX-
5	Ground	Power	Ground
6	Sync+	Input	RS485_A, Pulse Per Second
7	Power+	Power	DC 10-16 V(max 16 V)
8	Ground	Power	Ground
9	Ethernet_RX+	Input	100BASE-RX, RX+
10	Ethernet_RX-	Input	100BASE-RX, RX-
11	Ground	Power	Ground
12	Sync-	Input	RS485_B, Pulse Per Second

Table 2.1.1 LiDAR and Extensible Cable Connector Description

SYNC signal description

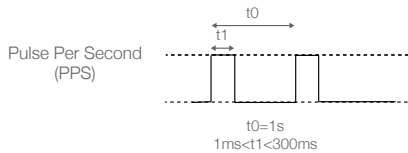

Figure 2.1.2 Sync signal description

Refer to the Software Development Kit (SDK) section for more information about the sync signal.

Power Cable and Sync Cable

The Livox Mid series cables package includes a power cable and sync cable.

Power Cable

Connect "A" to the power port of the Livox Converter and connect "B" to an external DC power supply. The connector type of this power cable is MOLEX105307-1202.

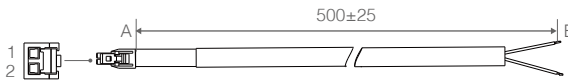

Figure 2.2.1 Power cable

Pin	Signal	Type	Description	Color
1	Power+	Power	DC 10-16 V (max 16 V)	Red
2	Ground	Power	Ground	Black

Table 2.2.1 Power cable description

Sync cable

Connect "A" into the sync port of the Livox Converter and connect "B" to the sync signal. The connector type of this sync cable is GHR-03V-S. Refer to the Data Synchronization section for more information.

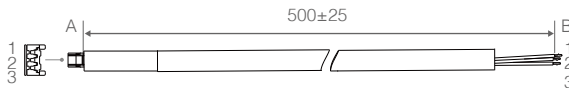

Figure 2.2.2 Sync cable

Pin	Signal	Type	Description	Color
1	Ground	Power	Ground	Black
2	Sync+	Input	RS485_A, Pulse Per Second	Blue
3	Sync-	Input	RS485_B, Pulse Per Second	White

Table 2.2.2 Sync cable description

Ethernet Port

The Livox Mid series LiDAR connector can be converted to an RJ45 Ethernet type port by using the Livox Converter. The Livox Mid series supports 100BASE-TX and uses two twisted pairs to send and receive data.

Mounting the Livox Mid Series

Effective Field of View (FOV) Range

The circular FOV of the Livox Mid-40 is 38.4°. The Livox Mid-100 is a three-in-one version of the Livox Mid-40. To ensure the performance of the Livox Mid-100, the FOV ranges of the three LiDAR sensors are overlapped. Consequently, the actual FOV of the Livox Mid-100 is 98.4°. When mounting a Livox Mid Series LiDAR sensor, make sure that the FOV is not blocked by any objects.

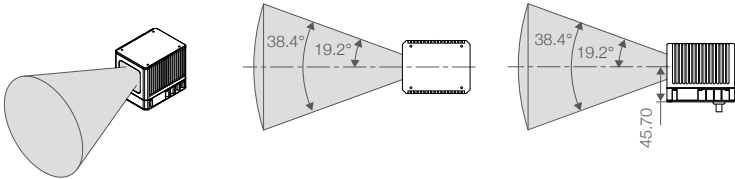

Figure 3.1.1 Effective FOV of the Livox Mid-40

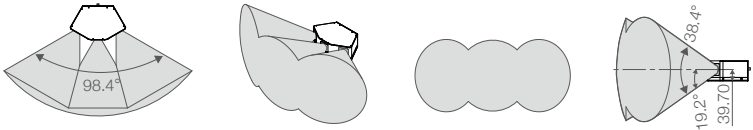

Figure 3.1.2 Effective FOV of the Livox Mid-100

Unit: mm

Dimensions

Livox Mid-40 Dimensions

Refer to the dimensions and the mounting holes in the figures below to mount or embed the Livox Mid-40 to or in an appropriate place on the target base. When the base is outfitted with 1/4 inch mounting holes, it is recommended to first attach the Livox Mid-40 to the mounting bracket and then mount the Livox Mid-40 using the 1/4 inch mounting hole on the mounting bracket. There are several M3 screw holes available on the sides of the mounting bracket to help mount the Livox Mid-40 based on the requirements.

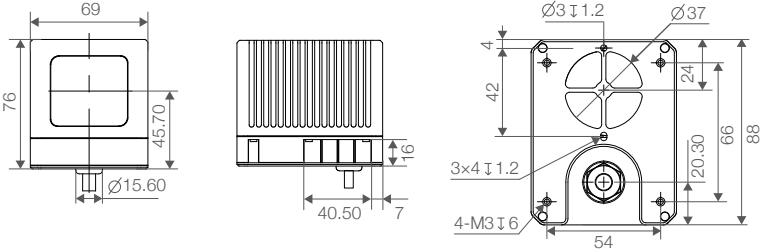

Figure 3.2.1 Livox Mid-40 Dimensions (refer to Appendix 1)

Unit: mm

Weight (with cable)	760 g
Dimensions	88 × 76 × 69 mm

Table 3-2-1 Livox Mid-40 Weight & Dimensions

Livox Mid-40 Mounting Bracket

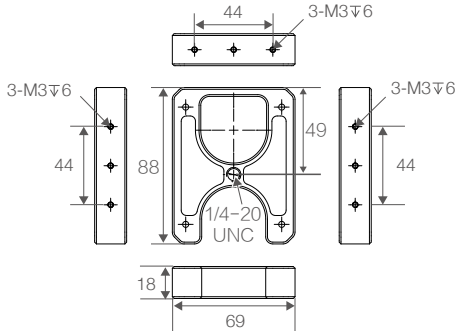

Unit: mm

Figure 3.2.2 Livox Mid-40 Mounting Bracket Dimensions (refer to Appendix 2)

Weight	101 g
Dimensions	88 × 69 × 18 mm

Table 3-2-2 Livox Mid-40 Mounting Bracket Weight & Dimensions

Livox Mid-100 Dimensions

The Livox Mid-100 is outfitted with four M3 mounting holes on the bottom, and can be mounted using the M3 screws. Additionally, a 1/4 inch mounting hole is also available on the center of the bottom. When mounting the Livox Mid-40 to a tripod or other target base outfitted with 1/4 inch mounting holes, users can use this hole. Refer to the dimensions and the mounting holes in the figures below to mount or embed the Livox Mid-100 to or in an appropriate place on the target base.

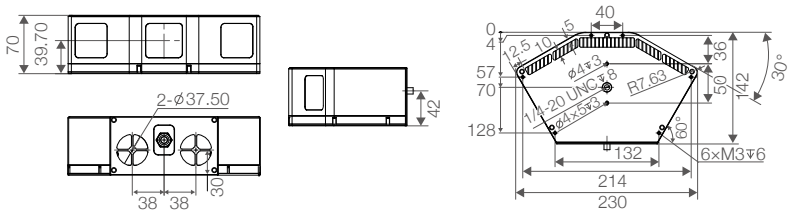

Figure 3.2.3 Livox Mid-100 Dimensions (refer to Appendix 3)

Unit: mm

Weight (with cable)	2200 g
Dimensions	142 × 70 × 230 mm

Table 3.2.3 Livox Mid-100 Weight & Dimensions

Livox Converter

Refer to the dimensions below to mount the Livox Converter.

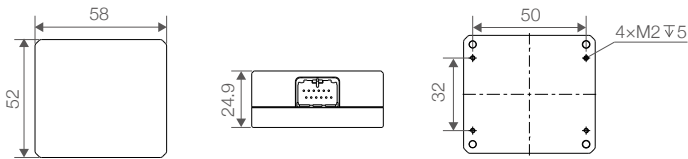

Figure 3.2.4 Livox Converter Dimensions (refer to Appendix 4)

Unit: mm

Weight	66 g
Dimensions	52 × 58 × 25 mm

Table 3.2.4 Livox Converter Weight & Dimensions

Getting Started

External Power Supply

The working voltage of the Livox Mid series is 10 V to 16 V. The working power of the Livox Mid-40 is 10 W, while the Livox Mid-100 is 30 W. After powering on, the Livox Mid series LiDAR sensors may reach peak power, which may last for short periods. The lower the temperature, the higher the peak power will be.

When powering on the Livox Mid-40 in an environment temperature of 4° F (-20° C), within the first 20 seconds the peak power can reach 40 W. When powering on the Livox Mid-100 in the same environment temperature, it may take 40 seconds to power on the three Livox Mid-40 LiDAR sensors, and the peak power can reach 67 W.

Make sure the power supply is suitable based on the peak power of the Livox Mid series LiDAR sensor. Refer to the figures below to see the relationship between the peak power and the environment temperature of the Livox Mid series. The value is for reference only. In normal conditions, the peak power is lower than in the figures below.

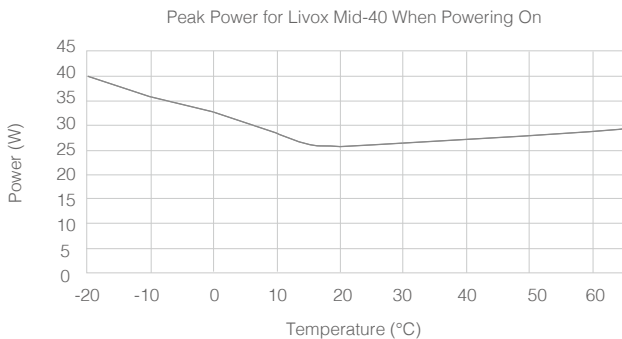

Figure 4.1.1 Relationship between the peak power and the temperature for the Livox Mid-40

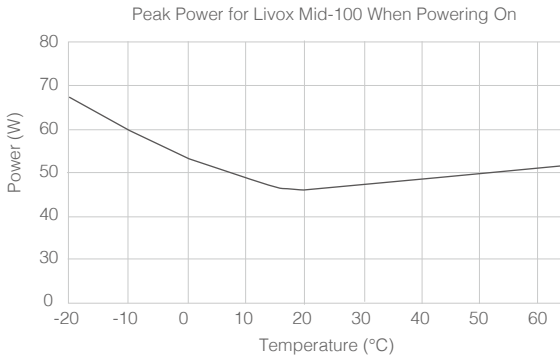

Figure 4.1.2 Relationship between the peak power and the temperature for the Livox Mid-100



- The working temperature range for the Livox Mid series is from -4° to 149° F (-20° to 65° C). DO NOT use this product outside of that range.
- In real situations, the power voltage may fluctuate due to the influence of the working environment. Make sure that the power voltage is always within the range between 10 to 16 V even with the fluctuations.

Connection

The Livox Mid series uses a compact and reliable electrical connector for power supply as well as control signal and data transmission. Refer to the Cables section for more information about the connector. The Livox Converter integrates a LiDAR port, a sync port, a power port, and an Ethernet port. To ensure optimal performance, it is recommended to always use a Livox Converter.

The Livox Mid series uses an Ethernet cable for data transmission and supports user datagram protocol (UDP). Both static and dynamic IP address configurations are supported and the addresses are assigned by default to the Livox Mid series LiDAR sensor using dynamic host configuration protocol (DHCP). The static and dynamic IP addresses are connected in different ways. The dynamic IP address is connected by default using a router with DHCP. To connect to the static IP address, make sure the Livox Mid series LiDAR is switched to static IP mode by using Livox Viewer or the SDK. The connections are the same for the Livox Mid-40 and Livox Mid-100.

The Livox Mid-40 is used in the example below.

Dynamic IP address:

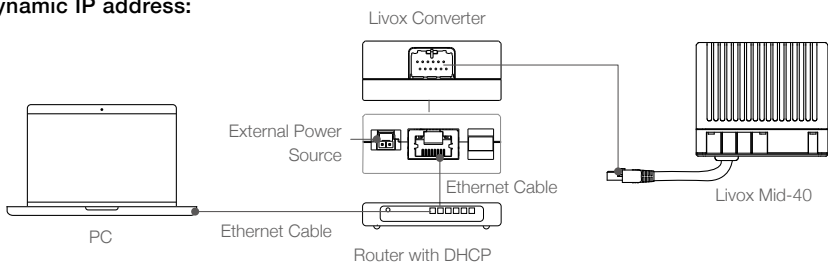



Figure 4.2.1 Connecting using dynamic IP address

1. Connect the Livox Mid-40 to the Livox Converter.
2. Connect the computer and the Livox Converter to the router using Ethernet cables. Make sure both the Livox Converter and the computer are connected to the LAN port on the router.
3. Connect the Livox Converter to an external power source.
4. Connect one end of the sync cable to the sync port and the other end to the designated sync signal. Note that the sync cable may not always be required.



- When connecting multiple Livox Mid-40 LiDAR sensors, connect them to one router, and then connect the router to a computer.

Static IP address:

1. Connect the Livox Mid-40, Livox Converter, router, external power source, and computer by following Figure 4.2.1.
2. Run Livox Viewer, click , and set the IP address of the Livox Mid-40 to static IP address. Note that the static IP address of a Livox Mid-40 should be 192.168.1.X. The X is related to the broadcast number of the LiDAR sensor. If the broadcast number ends with 1, X can be set to any number between 11 to 80. If the broadcast number ends with 2, X can be set to any number between 81 to 150. If the broadcast number ends with 3, X can be set to any number between 151 to 220.
3. Disconnect the Livox Mid-40, Livox Converter, router, external power source, and computer.
4. Set the IP address of your computer to static IP address. Note that the static IP address of your computer should be 192.168.1.X. X can be set to any number between 2 to 233 and should be different from the IP address of the Livox Mid series LiDAR sensor set in Step 2.

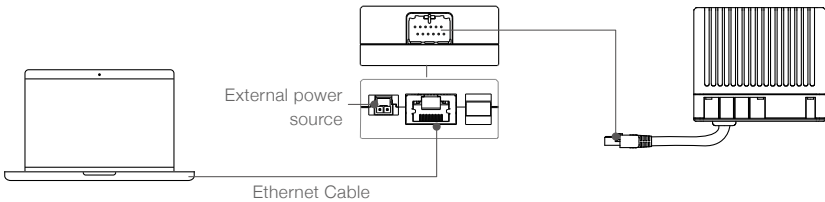

Figure 4.2.2 Connecting using static IP address

5. Connect the Livox Mid-40 to the Livox Converter.
6. Connect the Livox Converter to your computer using an Ethernet cable.
7. Connect the Livox Converter to an external power source.



- Make sure to set the IP address of the Livox Mid series LiDAR sensor back to dynamic IP address if it has been set to static IP address to use a router for connection. Also make sure to set your computer to dynamic IP address, and follow the instructions in the Dynamic IP address section.
- If multiple Livox Mid-40 LiDAR sensors are set to static IP addresses, make sure all the Livox Mid-40 LiDAR sensors have different IP addresses and use a switchboard to connect them to the computer.
- A Livox Mid-100 is equal to three Livox Mid-40 LiDAR sensors. Therefore, you should set three different static IP addresses to one Livox Mid-100.
- If more than 6 Livox Mid-40 LiDAR sensors are required, use a kilo mega switchboard or a kilo mega router.
- The broadcast number for each LiDAR sensor can be viewed in the Device Manager of Livox Viewer or the SDK. For the Livox Mid-40, the broadcast number will be its serial number ending in an additional "1". For the Livox Mid-100, the broadcast numbers of the three Livox Mid-40 LiDAR sensors will be the serial number ending in an additional "1", "2", or "3".
- In static IP address mode, the router is required only when you set the IP address of the LiDAR sensors .

Usage

Coordinates

Users can view the real-time point cloud data by using Livox Viewer and develop customizable applications using the Software Development Kit (SDK). Before learning about how to use Livox Viewer and the SDK, see the Cartesian and Spherical coordinates of the Livox Mid-40 and Livox Mid-100 below.

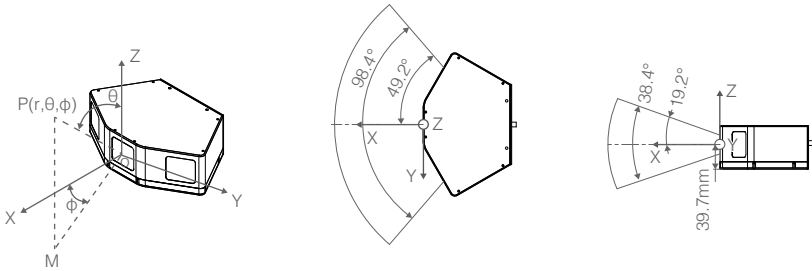

Figure 5.1.1 Coordinates of the Livox Mid-100

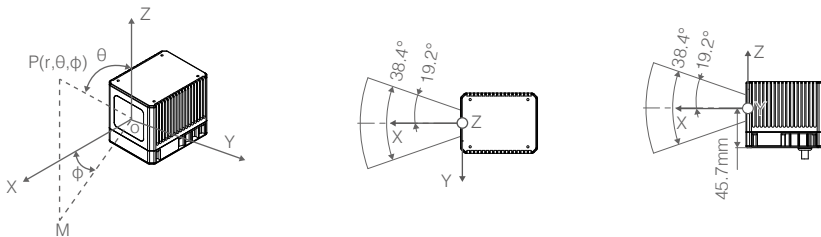

Figure 5.1.2 Coordinates of the Livox Mid-40

Output Data

The output information of Livox Mid series LiDAR sensors includes point cloud data, timestamp, and status codes.

Point Cloud Data

A point cloud is the collection of the points where the surface of an object was detected in the FOV of the LiDAR sensor. Each point contains the following information.

- Target reflectivity: 0 to 255. 0 to 150 corresponds to the reflectivity within the range of 0 to 100% in the Lambertian reflection model. 151 to 255 corresponds to the reflectivity of target objects with retroreflection properties.
- Coordinates: Can be expressed as Cartesian coordinates (x, y, z) and Spherical coordinates (r, θ, φ). The relationship between Cartesian and Spherical coordinates is shown in the figure below.

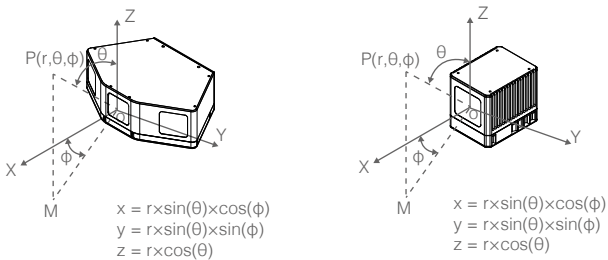

Figure 5.2.1.1 Relationship between Cartesian coordinates and Spherical coordinates

Timestamp

There are two ways to synchronize data with the Livox Mid series: IEEE 1588-2008 and Pulse Per Second (PPS).

IEEE 1588-2008: IEEE 1588-2008 is the Precision Time Protocol (PTP) enabling precise synchronization of clocks in measurement and control systems by Ethernet. Livox LiDAR sensors, as the ordinary clock in the PTP, only supports UDP/IPV4 for PTP. Livox LiDAR sensors support the following message events: Sync, Flow_up, Delay_req, Delay_resp.

PPS: PPS uses the sync cable for data synchronization. Refer to the Cables section for more information. The synchronization logic is shown in the figure below. The pulse interval in PPS is 1 s ($t_0 = 1 \text{ s}$) while the continuous time of high-level voltage is from 1 ms to 300 ms ($1 \text{ ms} < t_1 < 300 \text{ ms}$). The rising edge of PPS will reset the timestamp to zero. so the timestamp of the point cloud data indicates the duration between the point cloud sampling and the PPS rising edge.

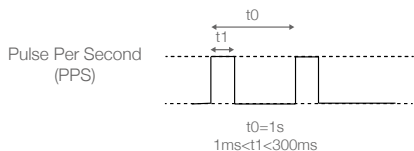

Figure 5.2.2.1 Pulse Per Second

Status Codes

The status codes display the current working status of the Livox Mid series LiDAR sensors. By checking the status codes, users can see the temperature status, voltage status, motor status, dust warning, service life warning, and PPS signal status. Status codes can be viewed in Livox Viewer or in the SDK. Refer to the Livox Viewer section for more information about how to check status codes.

Status	Description
Temperature status	Indicates if there is any temperature abnormality. Temperature status includes: normal, warning, and error.
Voltage status	Indicates if there is any internal voltage abnormality. Voltage status includes: normal, warning, and error.
Motor status	Indicates if there is any internal motor abnormality. Motor status includes: normal, warning, and error.
Dust warning	Indicates if a significant amount of dust is detected on the optical window, if the optical window is covered by objects, or if there is an object less than 0.3 meters away from the LiDAR sensor.
Service life warning	Indicates if the LiDAR sensor is nearing the end of its service life.
PPS signal status	Indicates whether the PPS sync signal is working normally.

Working States & Working Modes

The working states of the Livox Mid series includes initializing, normal, standby, power saving, and error.

Working states	Description
Initializing	The LiDAR sensor is powering on.
Normal	The LiDAR sensor is powered on and working normally.
Standby	The LiDAR sensor is powered on, but the laser beams are not active.
Power saving	All components are powered off apart from the communication module.
Error	The LiDAR sensor will enter error status when an error is detected and all the components are powered off apart from the communication module.

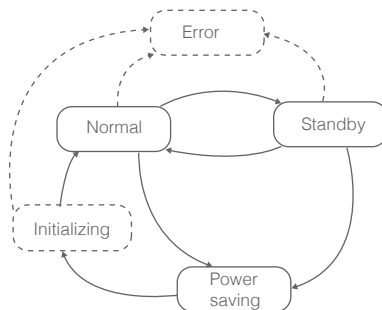

Figure 5.2.1 Relationship between the different working states

The Livox Mid series also has three working modes: Normal, Standby, and Power Saving. These modes can be set in Livox Viewer and SDK.

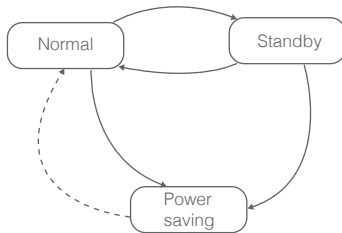

Figure 5.2.2 Relationship between the different working modes available in Livox Viewer

Rain/Fog Suppression

When the Livox Mid series is used in adverse weather conditions, it may detect atmospheric particles such as rain, fog, or dust. Rain/Fog Suppression decreases the false detection rate of atmospheric particles in adverse weather conditions.

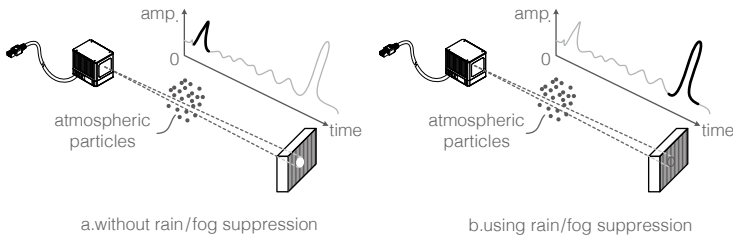

Figure 5.4.1 Comparison of false detection with and without using Rain/Fog Suppression

Note that Rain/Fog Suppression only limits the false detection rate of rain, fog, and dust. Additionally, Rain/Fog Suppression may also decrease the Livox Mid series ability to detect some surfaces with low reflectivity, such as glass or power cables. Only enable Rain/Fog Suppression when absolutely required. Rain/Fog Suppression can be enabled in the SDK. Refer to the Livox SDK Communication Protocol for more information.

Livox Viewer

Livox Viewer is a computer software designed for Livox LiDAR sensors and Livox Hub. Users can check real-time point clouds of all the Livox LiDAR sensors connected to a computer, and also record the point cloud data to view offline or for future application use.

Visit www.livoxtech.com to download the latest Livox Viewer. Livox Viewer supports WINDOWS® 7/8/10 (64 bit) and UBUNTU®16.04 (64 bit).



- Turn off firewalls on your computer before using Livox Viewer. Otherwise, Livox Viewer may not be able to detect the Livox LiDAR sensors.
- Make sure the graphic driver is correctly installed. Otherwise, Livox Viewer may not launch or may crash.

For Windows users: unzip the Livox Viewer file and click to open the .exe file named “Livox Viewer.”

For Ubuntu users: unzip the Livox Viewer file and click to open the “./livox_viewer.sh” file under the root directory.

Livox Viewer Homepage

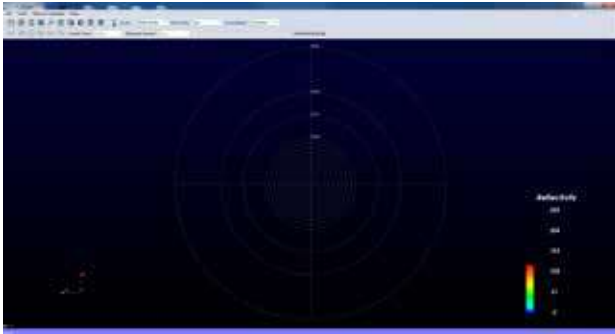

5.1.1 Livox Viewer Homepage

File: Click “Open File” to open a saved point cloud data file in .lvx format. Click “Open Device Manager” to open the Device Manager to scan and detect the connected LiDAR sensors. Click “Save as->.las file” to save the point cloud data in .las format. Click “Save as->.csv file” to save the point cloud data in CSV format. Click “Clear” to remove the point cloud data.

Tools: Click “Grid Property” to set the grid’s type, color, and coordinates. Click “Firmware Update” to check the firmware version of detected Livox LiDAR sensors and Livox Hub units, and also to update the firmware. Click “Extrinsic Parameter Tool” to import extrinsics. Click “Options” to set the file path to record point cloud data. Click “Lvx to Las Tool” to allow users to convert .lvx format files into .las format. Note that when clicking “Lvx to Las Tool”, the whole .lvx file will be converted to a .las file which contains only one point cloud image. The .lvx file cannot be converted to .las files frame by frame.

Net Adapter: Select the internet connection. Note that only a local area connection can be selected

Help: Click for more information about Livox Viewer.

 : Click to open a saved point cloud data file in .lvx format.

 : Click to open the Device Manager to search for all the Livox LiDAR sensors and Livox Hubs in the LAN.

 : Click to open the Lvx Manager when displaying the saved point cloud data.

 : Click this to open the spreadsheet to pick a certain area of the point cloud, and check the detailed information of this selected area of the point cloud.

 : Click to display or hide the grid. Livox Viewer displays a virtual grid composed of 13 concentric circles. The first 10 concentric circles, which are equally distanced, show the distance from 10 m to 100 m. The 11th, 12th, and 13th circles show the distance of 150 m, 200 m, and 300 m.

 : Click to automatically adjust the position of the point cloud on the grid so that the point cloud can

be viewed clearly

 : Click to choose the angle view. Choose from right view, front view, top view, and back view. The angle view can be manually adjusted using the mouse and keyboard.

- a. Zoom in or out using the mouse wheel.
- b. Hold the left mouse button and move the mouse to adjust the angle view.
- c. Press “Ctrl” on the keyboard, hold the left mouse button, and move the mouse to rotate the point cloud.
- d. Press “Shift” on the keyboard, hold the left mouse button, and move the mouse to move the grid.

 : Display or hide the color bar. The color bar works as a reference of the point cloud data. You can set to display the color bar according to the color depth or the reflectivity.

 : Click to select the way to color the point cloud. Users can select solid color or set based on reflectivity, or LiDAR ID. Note that by default the point cloud will be colored based on reflectivity.

 : Click to set the point size. Choose from 1 px, 2 px, 3 px, 4 px, and 5 px.

 : Click to set the original point cloud data format to Cartesian or Spherical coordinates.

 Viewer controls:



 : Click to rewind to the beginning (not available when checking real-time point clouds).

 : Click to fast-forward to the end (not available when checking real-time point clouds).

 : Click to rewind one frame (not available when checking real-time point clouds).

 : Click to fast-forward one frame (not available when checking real-time point clouds).

 : Click to play/pause.

 : When one or more Livox LiDAR sensors are connected, click  to start recording the live data. Click  again to stop recording.

 : Click to set the frame time. Choose from 50, 100, 200, 500, 1000, and 3000 ms. The longer the frame time is, the denser the point cloud will be. The recommended frame time is 1000 ms.

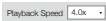
 : Click to set the frame speed. Choose from x0.5, x1.0, x2.0, and x4.0 (not available when checking real-time point clouds).

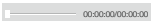
 Drag to adjust the time of the saved point cloud data file (not available when checking real-time point clouds).

Device Manager





5.1.2 Livox Viewer Device Manager

 : Connect all devices.

 : Disconnect all devices.

 : Display the point cloud data of all connected LiDAR sensors.

 : Hide the point cloud data of all connected LiDAR sensors.

Note that the two icons   can only display or hide the point cloud data displayed in Livox Viewer, but they will not enable or disable the LiDAR sensors from sampling point cloud data.

 : Click to check device properties. Check information such as the device type, work mode, and firmware version. Users can also set the working mode and choose between static or dynamic IP addresses for individual Livox LiDAR sensors.

 : Select the type of device you would like to check.

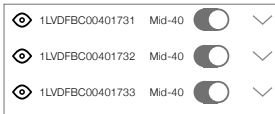





 : Displays all the devices in the LAN.

 : Check the working states. When in error state, users can check the status codes.



 : Display or hide the point cloud of the selected Livox LiDAR sensor.

 : Slide to connect or disconnect the selected Livox LiDAR sensor.



Checking Real-time Point Cloud Data

1. Connect the Livox LiDAR sensor, and run Livox Viewer. Click  to open Device Manager. The Device Manager will display all the devices in the LAN.
2. Select LiDAR in Device Manager.
3. Select a Livox LiDAR sensor to check, and click  to connect. Alternatively, select the Livox LiDAR sensor, right click, and click “Connect Device”. Click  to connect all Livox LiDAR sensors.
4. After connecting, click  to view the point cloud data.

Recording Point Cloud Data

When one or more Livox LiDAR sensors are connected, click  to start recording the live data. Click  again to stop recording.

Displaying Saved Point Cloud Data

Click  or click File > “open file” to open the saved point cloud data. Use the viewer controls to adjust the video. While displaying saved point cloud data, you can click  on the homepage. The Lvx Manager window will appear. You can click  to hide or display the selected Livox LiDAR sensor.

Extrinsics Calibration

The Livox Mid-100 is a three-in-one version of the Livox Mid-40. Before delivery, the Livox Mid-100 has already been calibrated. However, if more than one Livox Mid-100 or Livox Mid-40 are being used, the Livox LiDAR sensors must be recalibrated by importing the extrinsics. Follow the steps below to import the extrinsics.

Click Tools > Extrinsic Parameter Tool to enter the Extrinsic Parameter Tool page.

Make sure the format of the code in the extrinsics import page matches the example below:

```
<code>{
  "firmware_version": "1.0",
  "encoding": "UTF-8"
}
</code>
<code>{
  "livox": {
    "device": {
      "roll": 0, "pitch": 0, "yaw": 0, "x": 0.1, "y": 0, "z": 0, "id": "1LVDFBC00401731", "device": "1LVDFBC00401731"
    },
    "device": {
      "roll": 0, "pitch": 0, "yaw": 0, "x": 0.1, "y": 0, "z": 0, "id": "1LVDFBC00401732", "device": "1LVDFBC00401732"
    },
    "device": {
      "roll": 0, "pitch": 0, "yaw": 0, "x": 0.1, "y": 0, "z": 0, "id": "1LVDFBC00401733", "device": "1LVDFBC00401733"
    }
  }
}
</code>
```

In the example above, “1LVDFBC00401731” represents the broadcast code of the Livox LiDAR sensor. Click “Start Cali” to check the coordinates of all the Livox LiDAR sensors connected. Users can manually enter each coordinate.

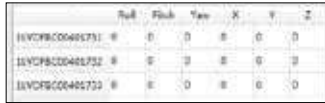

	Roll	Pitch	Yaw	X	Y	Z
1LVDFBC00401731	0	0	0	0	0	0
1LVDFBC00401732	0	0	0	0	0	0
1LVDFBC00401733	0	0	0	0	0	0

Alternatively, select a coordinate and use the wheels at the bottom of the screen to adjust the coordinates. Press “Ctrl” when using the wheels to select multiple coordinates in the same column to adjust them simultaneously.

Click “Load From File” to import extrinsics.

Click “Read From Device” to check the current coordinates of all Livox LiDAR sensors. All Livox LiDAR sensors can store extrinsics. Storing extrinsics will not affect the real-time point cloud data. Refer to the Software Development Kit (SDK) section for more information.

Click “Save Param As” to save the coordinates of all detected Livox LiDAR sensors.

Click “Apply” to confirm the new coordinates. A pop-up window will appear. Choose to write the current extrinsics to the Livox LiDAR sensor. Otherwise, there will be no change in the coordinates.



- The new coordinates will only be effective after you click Apply.
- For more details regarding the extrinsic parameters, please refer to the SDK Communication Protocol.

Switching the Angle View

Click the following buttons to change the angle view of the point clouds:



Right View Front View Top View Back View

Alternatively, the angle view can also be adjusted using a mouse and keyboard.

- a. Zoom in or out using the mouse wheel.
- b. Hold the left mouse button and move the mouse to adjust the angle view.
- c. Press “Ctrl” on the keyboard, hold the left mouse button, and move the mouse to rotate the point cloud.
- d. Press “Shift” on the keyboard, hold the left mouse button, and move the mouse to move the grid.

Firmware Update

The firmware of Livox LiDAR sensors and Livox Hub can be updated by using Livox Viewer. To update the firmware, follow the steps below:

1. Click Tools > Firmware Update. A page will appear displaying all connected devices.
2. Select “Lidar Update” under Update Mode to display all detected Livox LiDAR sensors.
3. Click “Check Firmware” to check the current firmware version of selected Livox LiDAR sensors.
4. Select the firmware version under “Firmware Version”, and click “Download” to download the firmware to the computer.
5. After downloading the file, select the Livox LiDAR sensor you wish to update under “Firmware Update” and click “...” to select the downloaded firmware.
6. Click “Start” to update the firmware of the selected Livox LiDAR sensor.
7. The Livox LiDAR sensor will restart and reconnect to the computer after the update. Repeat the steps above if the update fails.



Make sure the computer is connected to the internet when downloading the firmware. After the firmware is downloaded, internet connection is not required.

Software Development Kit (SDK)

Besides using Livox Viewer to check real-time point cloud data, users can also use the SDK to apply the point cloud data acquired from Livox LiDAR sensors to different scenarios.

SDK Communication Protocol

There are two types of communication protocols between the user and a Livox LiDAR sensor, and the protocol formats of these two kinds of data are different. The specific functions and differences of these types of communications are as follows:

Control Command Data: Configuration and query of LiDAR parameters and status information.

Point Cloud Data: Point cloud coordinate data generated by LiDAR.

Both communication protocols are located in the data segment of the UDP package and stored in little-endian format.

To download the Livox SDK Communication Protocol and Livox SDK API Reference, please visit:

<https://www.livoxtech.com/sdk>

Storage, Transportation, and Maintenance

Storage

The storage temperature range for the Livox Mid series is from -40° to 185° F (-40° to 85° C). Keep Livox Mid series LiDAR sensors in a dry and dust-free environment.

Make sure Livox Mid series LiDAR sensors are not exposed to environments containing poisonous or corrosive gases or materials.

DO NOT drop Livox Mid Series LiDAR sensors and always be careful when placing a LiDAR sensor in storage or taking it out of storage.

If a Livox Mid series LiDAR sensor is not to be used for more than three months, regularly check the sensors and connectors for abnormalities.

Transportation

Before transportation, place Livox Mid series LiDAR sensors in a suitable box for transportation and make sure it is secure.

Make sure to place foam inside the transportation box and that the box is clean and dry.

DO NOT drop Livox Mid series LiDAR sensors and always be careful when carrying a LiDAR sensor.

Maintenance

In normal conditions, the only maintenance required for the Livox Mid series is to clean the LiDAR sensor's optical window. Dust and stains on the optical window can negatively affect the performance of the LiDAR sensor. Make sure to regularly clean the optical window to prevent this from happening.

First, check the surface of the optical window to see if cleaning is necessary. If it is necessary to clean, follow the steps below:

1. Use compressed or canned air: DO NOT wipe a dusty optical window, as it will only cause more damage. Dust the optical window with compressed or canned air before wiping the optical window. If the optical window has no visible stains afterward, it is not necessary to wipe it also.
2. Wipe the stains: DO NOT wipe using a dry lens tissue, as it will scratch the surface of the optical window. Use the lens tissue provided with isopropyl alcohol. Wipe slowly to remove the dirt instead of redistributing it on the surface of the optical window.

If the optical window is still dirty, a mild soap solution can be used to gently wash the window. Repeat Step 2 to remove any remaining soap residue.

Troubleshooting

The table below shows you how to troubleshoot and resolve common issues with Livox Mid series LiDAR sensors. If the issue persists, please contact Livox.

Issue	Resolution
Cannot detect the LiDAR sensor	<p>Make sure that all cables are correctly wired.</p> <p>Make sure the voltage and power supply is suitable. The voltage should be between 10 and 16 V and the power supply should be above 60 W.</p> <p>Make sure that the LiDAR sensor is not connected to other software.</p> <p>Make sure LAN is selected.</p> <p>Make sure no security software installed that would block Ethernet broadcasts.</p> <p>If the issues persists, try to turn off all firewalls and search again.</p> <p>Make sure the packet output of all connected devices using another application (e.g., Wireshark).</p>
Cannot connect to the detected LiDAR sensor/ Cannot start sampling	<p>Make sure that the power and Ethernet cables are correctly connected.</p> <p>Make sure the voltage and power supply is suitable. The voltage should be between 10 and 16 V and the power supply should be above 60 W.</p> <p>If the issue persists, reboot the LiDAR sensor and restart the software.</p>
No data received	<p>Make sure the packet output of all connected devices using another application (e.g., Wireshark).</p>

After-sales information

Visit www.livoxtech.com/support to check the after-sales policy and warranty conditions for Livox LiDAR sensors.

Appendix

Appendix 1

Livox Mid-40 Dimensions (unit: mm)

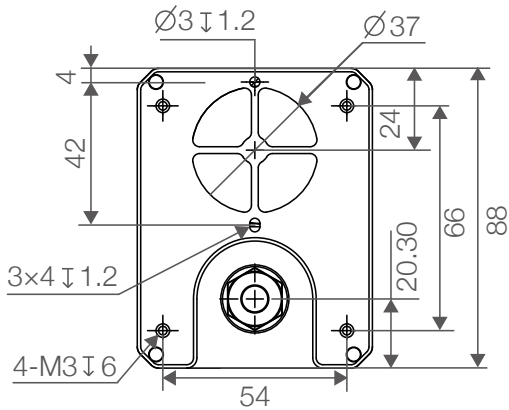
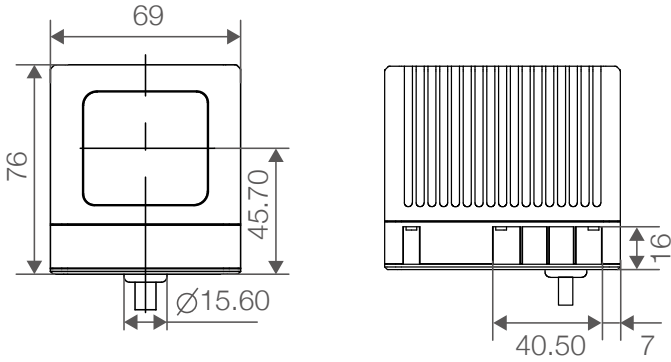

Appendix 4

Livox Converter Dimensions (unit: mm)

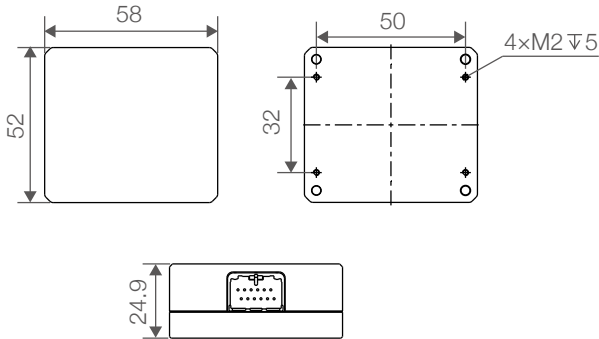

Specifications

Livox Mid-40/ Livox Mid-100	
Operation Temperature Range	-4° to 149° F (-20° to 65° C)
Laser Wavelength	905 nm
Laser Safety	Class 1 (IEC 60825-1:2014) eye safe
Detection Range (@100 klx)	90 m @ 10% reflectivity; 130 m @ 20% reflectivity; 260 m @ 80% reflectivity
FOV	Livox Mid-40: 38.4° (circular) Livox Mid-100: 98.4° (Horizontal) × 38.4° (Vertical)
Range Precision (1σ @ 20 m)	2 cm
Angular Accuracy	< 0.1°
Beam Divergence	0.28° (Vertical) × 0.03° (Horizontal)
Point Rate	Livox Mid-40: 100,000 points/s; Livox Mid-100: 300,000 points/s
Data Latency	≤ 2 ms
False Alarm Ratio (@100 klx)	< 0.01%
IP Rating	IP67
Power	Livox Mid-40: 10 W (Average) 40 W (Peak) Livox Mid-100: 30 W (Average) 67 W(Peak)
Power Supply Voltage Range	10 ~ 16 V (DC Power supply only)
Dimensions	Livox Mid-40: 88×69×76 mm Livox Mid-100: 142×70×230 mm
Weight	Livox Mid-40: 760 g Livox Mid-100: 2200 g
Livox Mid-40 Mounting Bracket	
Dimensions	88×69×18 mm
Weight	101 g
Livox Converter	
Dimensions	52×58×25 mm
Weight	66 g

Copyright © 2019 Livox Tech. All Rights Reserved.

Livox and Livox Mid are trademarks of Livox Technology Company Limited.

Windows is a registered trademark of Microsoft Corporation in United States and other countries.